

IMPLANTY 2018

OD IDEI DO KOMERCJALIZACJI

28 CZERWCA 2018



Spersonalizowane implanty weterynaryjne

Agnieszka Chmielewska^{1, 2}, Bartłomiej Wysocki^{1, 2}, Wojciech Świążkowski¹

¹Politechnika Warszawska, Wydział Inżynierii Materiałowej, Warszawa,

²Materialscare Sp. z o. o., Białystok, agnieszka.chmielewska@materialscare.eu

Przygotowanie modelu CAD

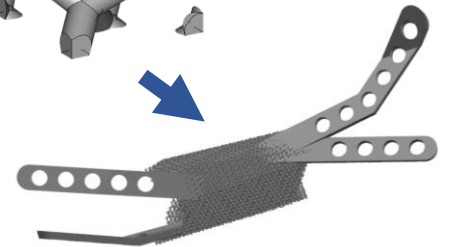
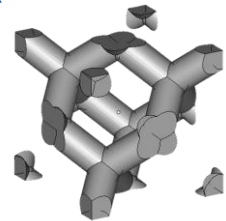
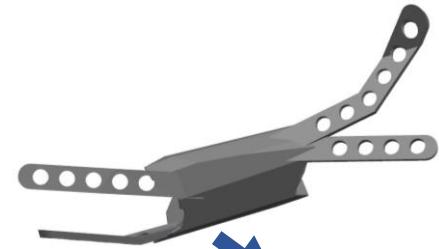
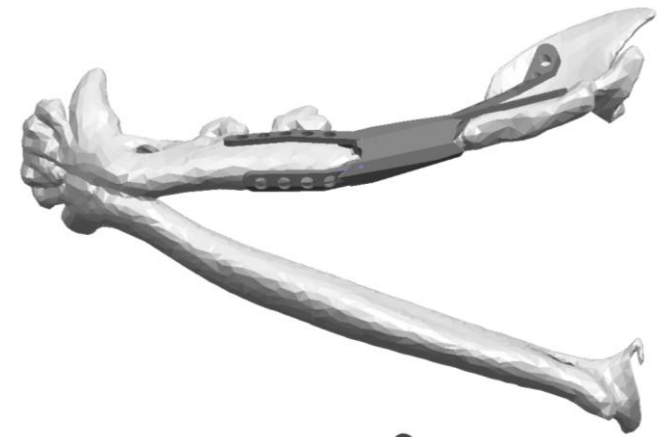
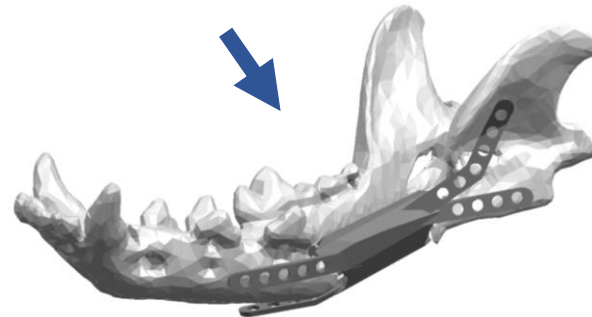
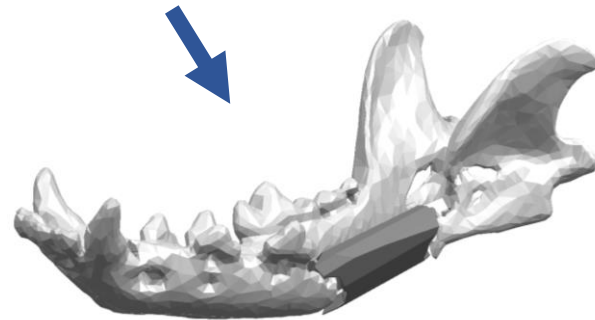

Wytwarzanie implantu

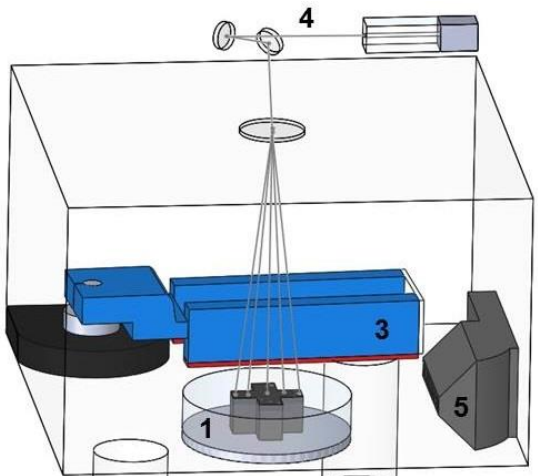

Titanium Powder

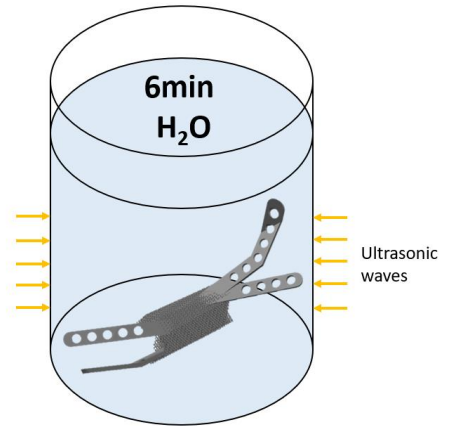
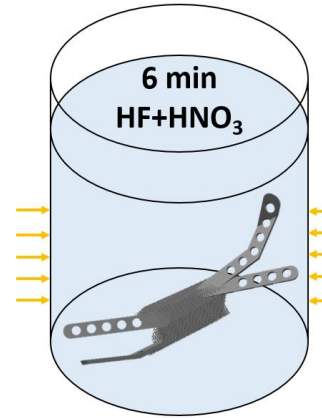
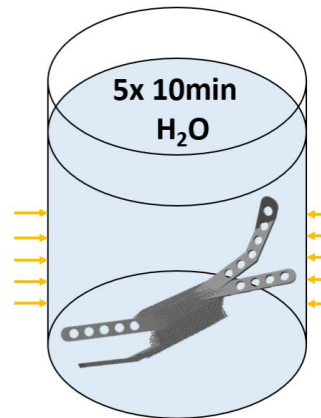
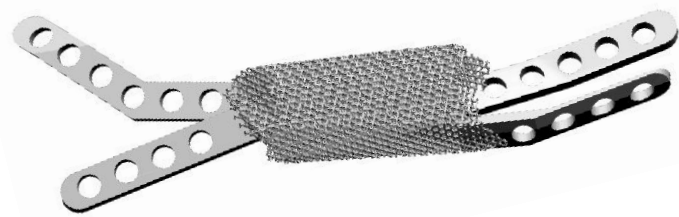
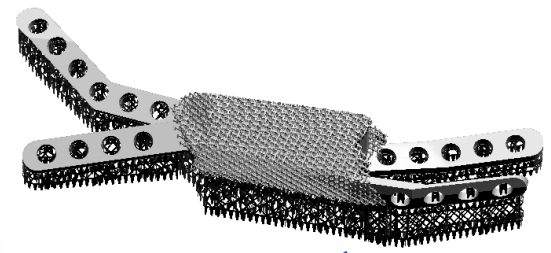
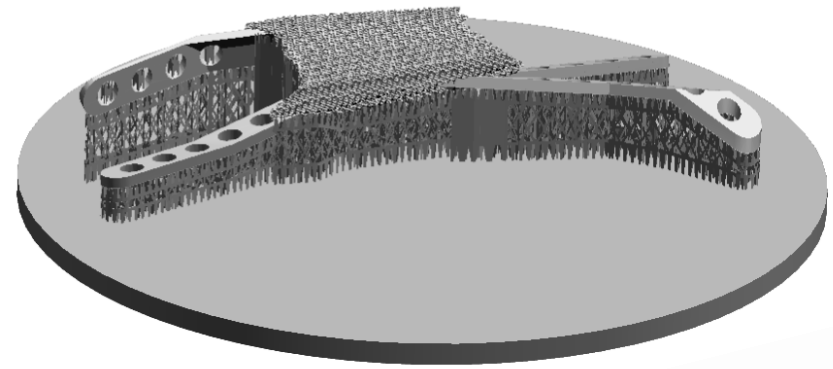

Wszczepienie implantu

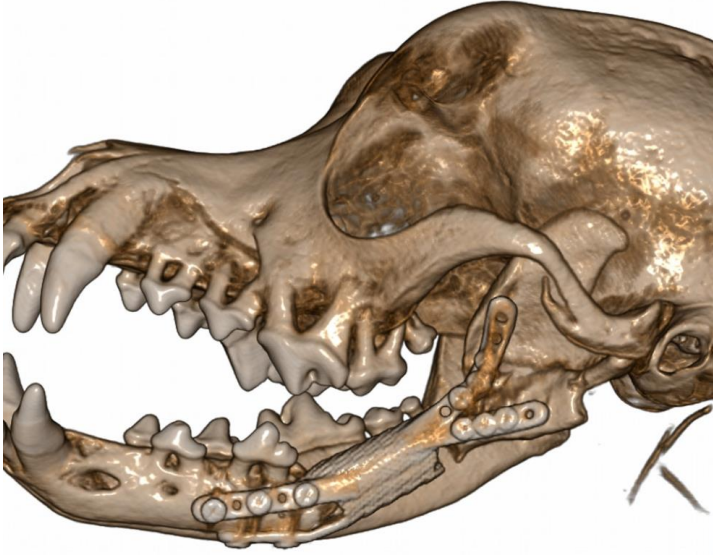
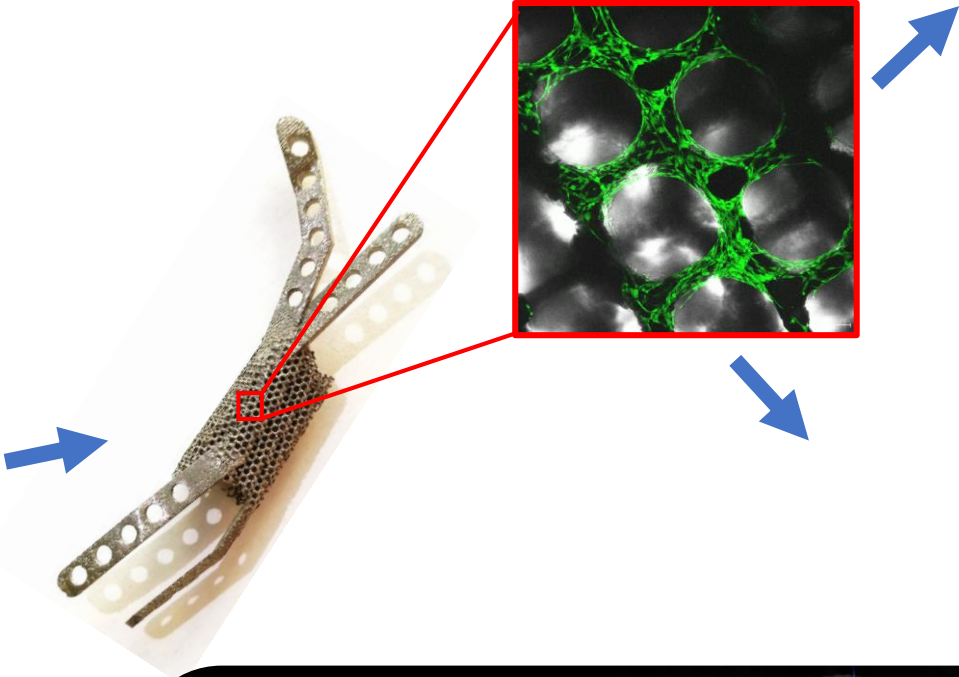
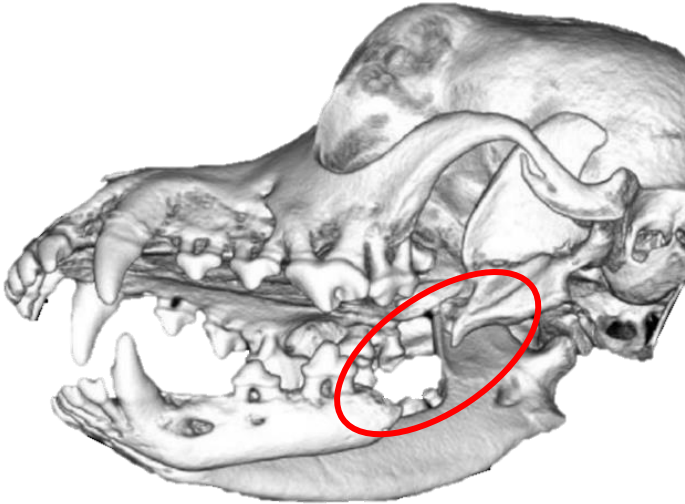

Dziękuję za uwagę